

Bat Pop-up Card

By Jeremy Shafer ©2002

This would make a good wedding invitation for Batman, but he might not find time in his busy schedule to fold it or even get married for that matter!

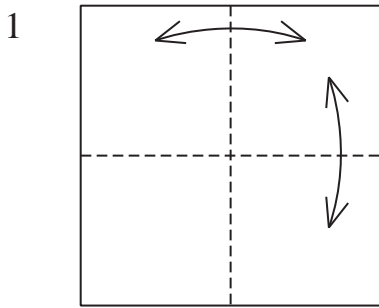
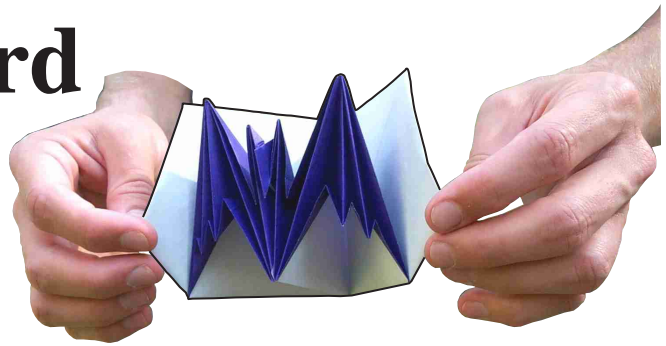

Valley-fold and unfold.

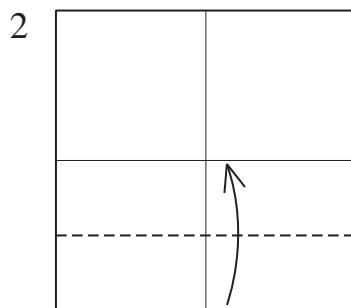

Valley-fold.

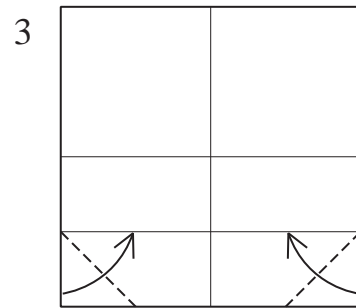

Valley-fold.

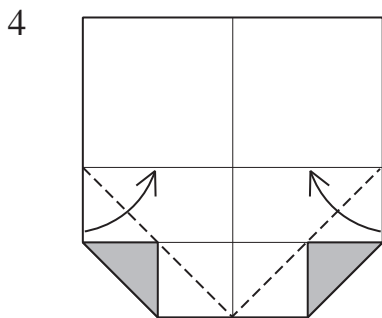

Valley-fold.

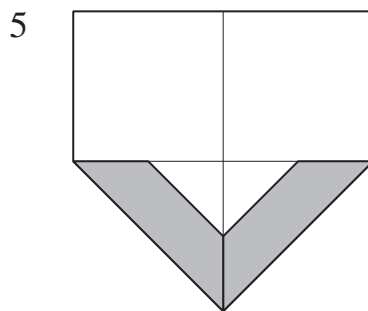

Turn-over.

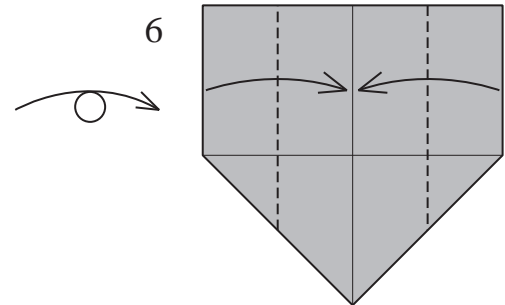

Valley-fold.

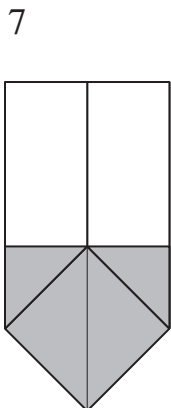

Rotate 180°.

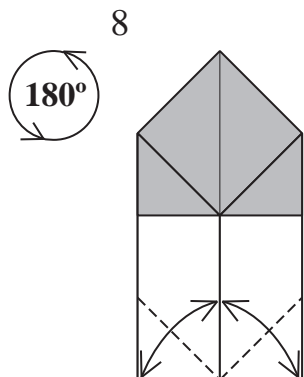

Valley-fold and unfold.

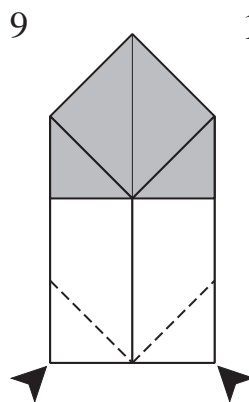

Reverse-fold

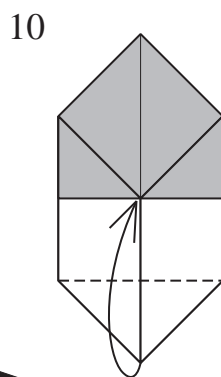

Valley-fold.

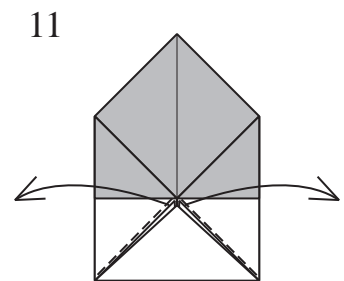

Pull the two interior flaps as far apart as possible and flatten.

12

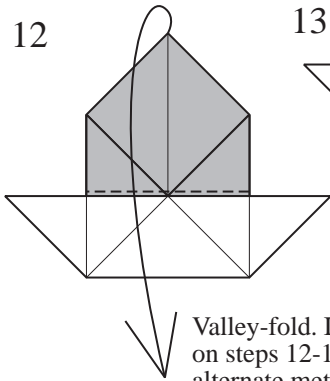

Valley-fold. If you get stuck on steps 12-17, try the alternate method shown in the cloud. It's easier but results in an extra crease.

13

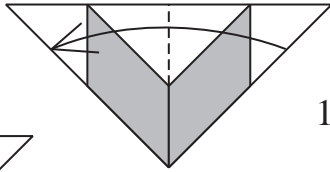

Valley-fold.

14

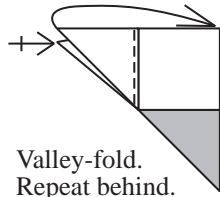

Valley-fold. Repeat behind.

15

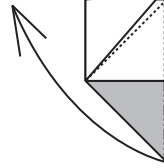

Reverse-fold the interior colored flap. The white portion stays in place.

16

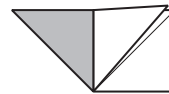

Rotate 90°.

17

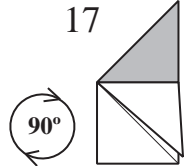

Like this.

Step 12-16 Alternate Method

12

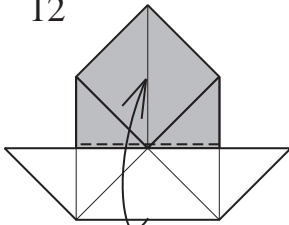

Valley-fold.

13

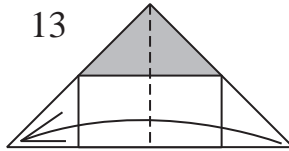

Valley-fold in half.

14

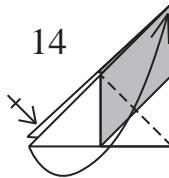

Valley-fold one flap. Repeat behind.

15



Pull out the interior flap.

17



Like this.

16



Valley-fold.

18

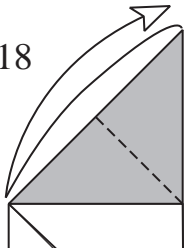

Valley-fold and unfold.

19

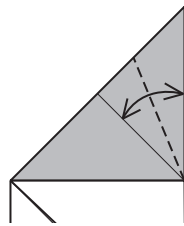

Valley-fold and unfold.

20

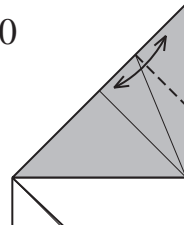

Valley-fold at the existing crease and unfold.

21

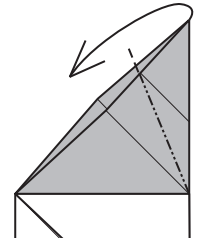

Reverse-fold.

22

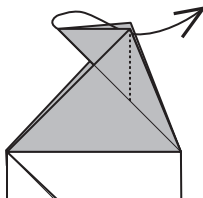

Reverse-fold.

23

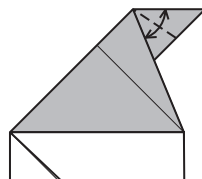

Valley-fold and unfold.

24

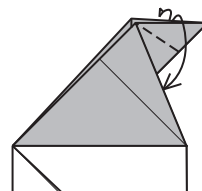

Outside-reverse-fold.

25

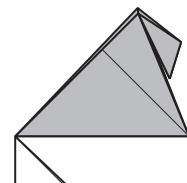

Flatten well.

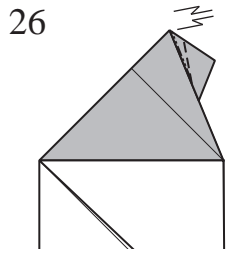

Crimp.

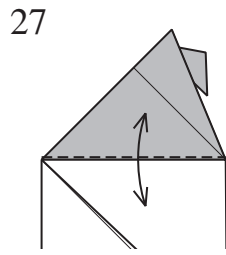

Valley-fold and unfold.

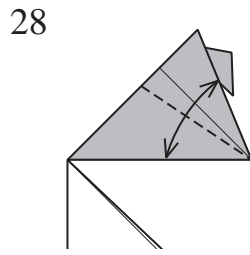

Valley-fold and unfold.

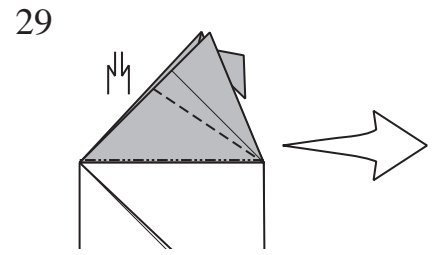

Crimp.

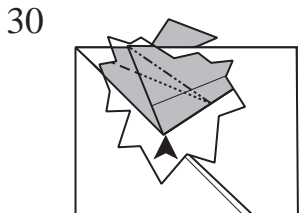

Cut-away view. Reverse-fold.

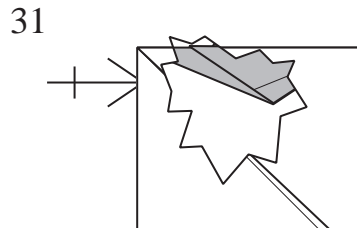

Like this. Repeat step 30 behind.

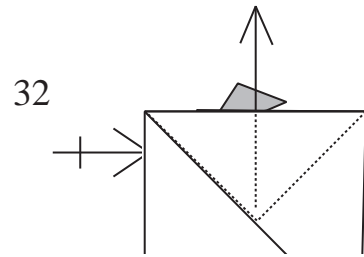

Pull out the right triangular flap. Repeat behind.

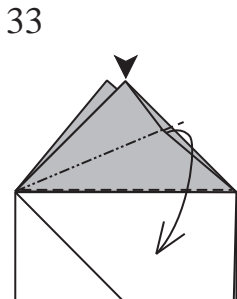

Squash.

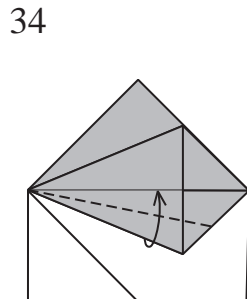

Valley-fold.

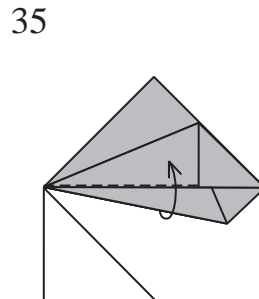

Valley-fold.

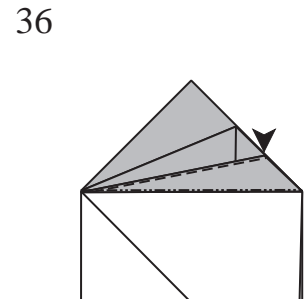

Reverse-fold.

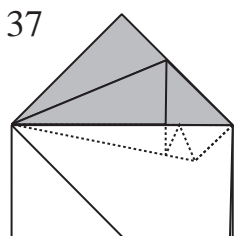

This is how the interior edges end up.

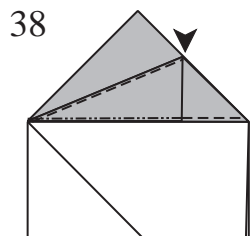

Reverse-fold.

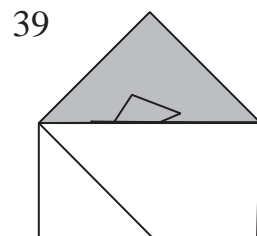

Turn-over.

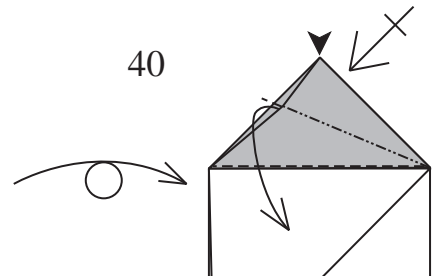

Repeat steps 33-39.

41

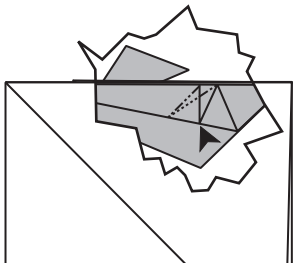

Cut-away view.
Reverse-fold.

42

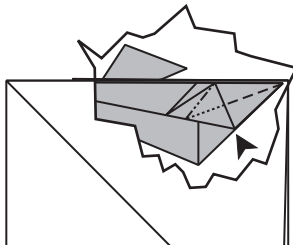

Reverse-fold.

43

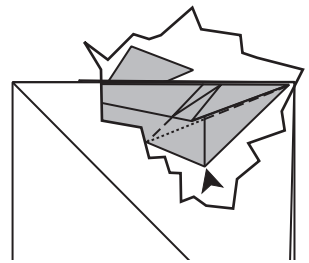

Reverse-fold.

44

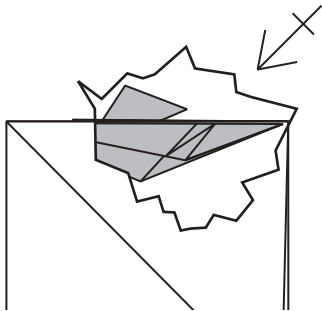

Like this. Repeat
steps 41-43 behind.

45

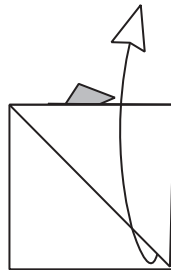
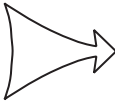

Bring up the flap.

46

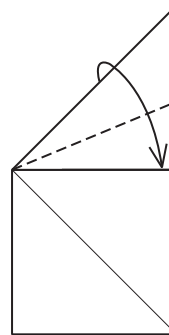

Valley-fold.

47

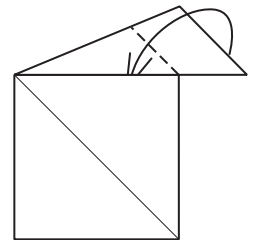

Valley-fold,
tucking the flap
into the pocket.

48

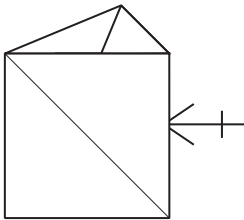

Repeat steps 45-48 behind.

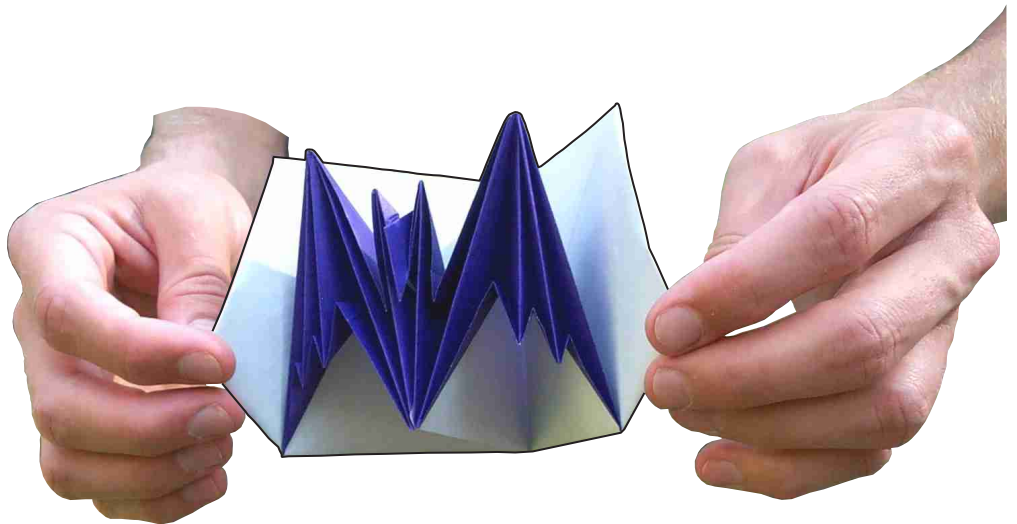

Pop-up Bat is ready for a night
out on the town or perhaps in
the seclusion of an envelope.